











36 503 985



- cover plate 120 x 120 mm
- temperature control handle with safety limit stop at 38°C
- thermostat cartridge

Fits: IMO, MEM, CL.1, CYO

	Brushed Chrome	36 503 985-93
	Chrome	36 503 985-00
	Brushed Platinum	36 503 985-06
	Platinum	36 503 985-08
	Dark Chrome	36 503 985-19
	Brushed Light Gold	36 503 985-27
	Brushed Durabronze (23kt Gold)	36 503 985-28
	Matte Black	36 503 985-33
	Brushed Champagne (22kt Gold)	36 503 985-46
	Champagne (22kt Gold)	36 503 985-47
	Brushed Dark Platinum	36 503 985-99

Required miscellaneous



- xTOOL Concealed thermostat module without volume control -** 35 503 970 90
- max. recess depth 160 mm
 - min. recess depth 95 mm

36 503 985

mm [inches]

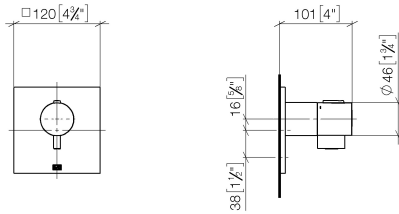

Flow rate chart

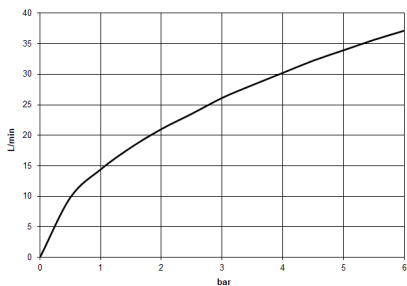

3551197090 + 36503xxx-FF + 366x7xxx-FF

Certificates

WRAS_2011026.

DVGW_DW-
6512DN0706.

LGA_29930.

LGA_29932.

36 503 985

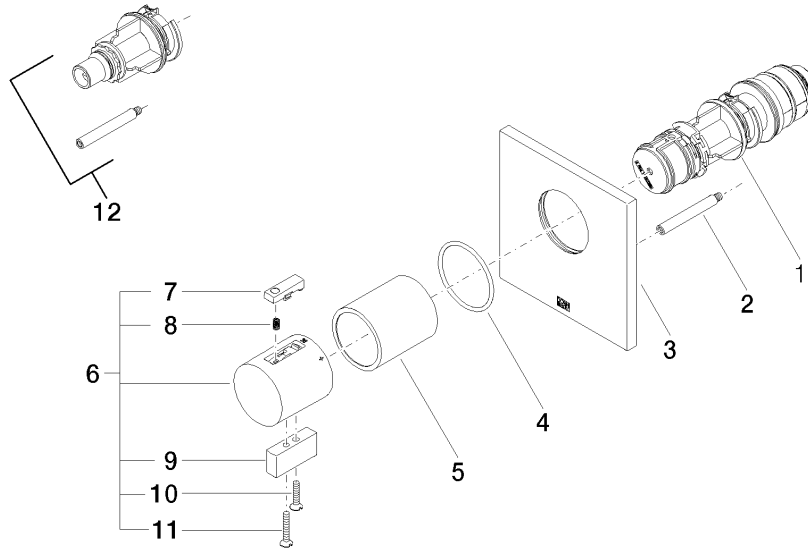

Spare parts list

No.	Item Number	Name	Quantity used	Delivery time
1	90 15 02 063 00 90	cartridge	1	2
2	90 31 09 095 00 90	bar	1	2
3	09 11 02 196-93	cover	1	60
4	90 14 10 049 00 90	seal	1	2
5	90 21 02 112 00-93	sleeve	1	-
Spare part can no longer be ordered, please order the replacement item				
6	04 17 33 006 00-93	handle	1	60
7	90 21 33 011 00-13	handle	1	2
8	90 16 02 027 00 90	spring	1	2
9	09 20 33 006-93	handle	1	20
10	09 30 30 159-93	screw	1	20
11	09 30 30 160-93	screw	1	20
12	12 178 970 90	Extension 46 mm -	1	2